

INNENTÜREN



Weißlacktüren
CPL Türen
Beschlüge
Zubehör







Verlege- und Montageanleitungen
finden Sie auf unserer website
www.master-kollektion.de/downloads/
oder scannen Sie den QR-Code.

4 - 5

Passen sich jedem Wohnstil an
Weisslacktüren

6-15

Türen mit dem gewissen Extra
Designtüren

16-23

Klassisch, elegant und hochwertig
Stiltüren

24-29

Erzeugen Wärme und Wohnlichkeit
CPL Türen

30-31

Sie öffnen Ihre Türen
Beschläge

32-37

Alles was Die Tür braucht
**Zargen
Technik**

38-39

Alles auf einen Blick
Türen-Übersicht



Beschreibung der Details:



Türblattprofil
Eckkante



ähnl.
RAL 9010



auch in ähnl.
RAL 9003
erhältlich (Kleine
Rundkante)

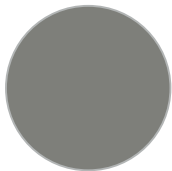

auch in
RAL 7037
erhältlich (Kleine
Rundkante)

Optional mit folgenden
Funktionen erhältlich:

[1] Schallschutz



[2] Einbruchhemmung



[3] Klimabeständigkeit



[4] Feuer-/Rauchschutz



Eckkante
[1] [2] [3] [4]



LA 300
[1] [3]



LA 301 B
[1] [3]

Weißlacktüren Eckkante



LA 301S
[1] [3]



LA 301M
[1] [3]



LA 302
[1] [3]

Wohnwert
erhalten
Wohnlichkeit
erschaffen

Weißlack-Innentüren - schlicht
und edel - sind absolut im Trend
und harmonieren ausgezeichnet
mit allen Stilrichtungen moderner
Wohnrichtungen



Beschreibung der Details:



Türblattprofil
Eckkante



4x 10 mm breite
geprägte Linien



ähnl.
RAL 9010

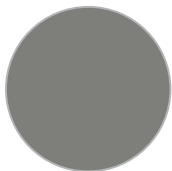

auch in
RAL 7037
erhältlich (Kleine
Rundkante)

Optional mit folgenden
Funktionen erhältlich:

[1] Schallschutz



[2] Einbruchhemmung



[3] Klimabeständigkeit



[4] Feuer-/Rauchschutz

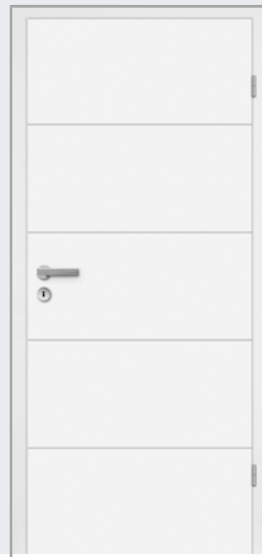

Venedig
[1] [2] [3] [4]



Venedig LA 303
[1] [3]



Venedig LA 301B
[1] [3]

Designtüren Venedig



Venedig LA 301S
[1] [3]

Venedig LA 301M
[1] [3]

Venedig LA 302
[1] [3]

Design und
zeitlose
Modernität -
elegante
Leichtigkeit
für Ihren
Wohnraum

Innentüren mit dem gewissen
Extra - die 10 mm breiten
Querprägungen verleihen Ihrem
Zuhause eine besondere Note



Beschreibung der Details:



Türblattprofil
Kleine Rundkante



4x3 mm V-Fuge
geprägt



ähnl.
RAL 9003

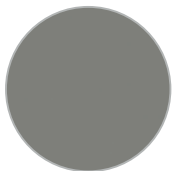

auch in
RAL 7037
erhältlich (Kleine
Rundkante)

Optional mit folgenden
Funktionen erhältlich:

[1] Schallschutz



[2] Einbruchhemmung



[3] Klimabeständigkeit



[4] Feuer-/Rauchschutz

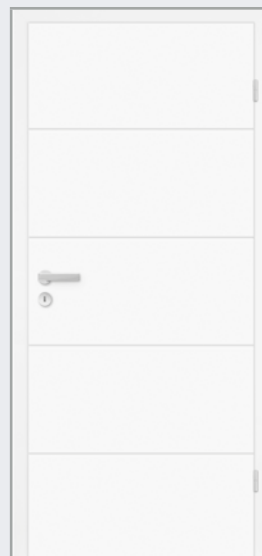

Venedig
[1] [2] [3] [4]



Venedig LA 303
[1] [3]



Venedig LA 301B
[1] [3]

Designtüren

Venedig 9003



Venedig LA 301S
[1] [3]



Venedig LA 301M
[1] [3]



Venedig LA 302
[1] [3]

Das weißere
Weiß -
ein Statement
für ein
individuelles
Stilgefühl

Durch die Verwendung von offenen Architekturen werden die Einrichtungen immer heller und Tageslicht durchflutet die Wohnräume. Innentüren in „Extra-Weiß“ fügen sich wunderbar in moderne, helle Räume ein.



Beschreibung der Details:



Türblattprofil
Eckkante



2x 10 mm breite
geprägte Linien



ähnl.
RAL 9010

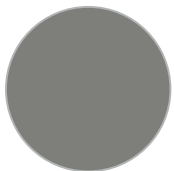

auch in
RAL 7037
erhältlich (Kleine
Rundkante)

Optional mit folgenden
Funktionen erhältlich:

[1] Schallschutz



[2] Einbruchhemmung



[3] Klimabeständigkeit



[4] Feuer-/Rauchschutz

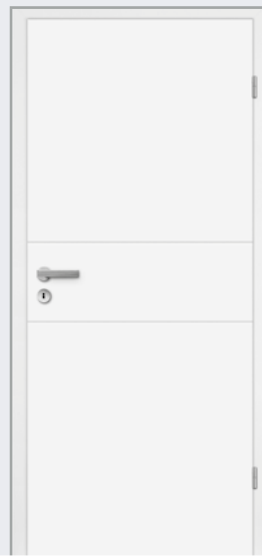

Varese
[1] [2] [3] [4]



Varese LA 303
[1] [3]



Varese LA 301B
[1] [3]



Designtüren Varese



Varese LA 301S
[1] [3]

Varese LA 301M
[1] [3]

Varese LA 302
[1] [3]

Elegante
Aufwertung für
Ihre Räume -
für eine
angenehme
Wohn-
atmosphäre

Innentüren mit dezenten
Querprägungen - schlicht
und zeitlos - setzen optische
Akzente und passen zu jedem
Einrichtungstil.



Beschreibung der Details:



Türblattprofil
mit kleiner
Rundkante



2x3 mm V-Fuge
geprägt



ähnl.
RAL 9003

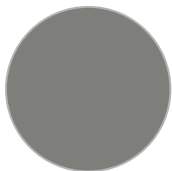

auch in
RAL 7037
erhältlich (Kleine
Rundkante)

Optional mit folgenden
Funktionen erhältlich:

[1] Schallschutz



[2] Einbruchhemmung



[3] Klimabeständigkeit



[4] Feuer-/Rauchschutz



Varese
[1] [2] [3] [4]



Varese LA 303
[1] [3]



Varese LA 301B
[1] [3]



Designtüren

Varese 9003



Varese LA 301S
[1] [3]



Varese LA 301M
[1] [3]



Varese LA 302
[1] [3]

Das weißere
Weiß -
aktuell und
elegant

Die Weißlacktüren im besonders strahlenden Weiß sind eine aktuelle Interpretation des Farbklassikers. Dieser Farbton passt perfekt für puristische oder einfache Wohnlandschaften.



Beschreibung der Details:



Türblattprofil
Eckkante



ähnl.
RAL 9010



Bologna
[1] [2] [3] [4]



Bologna LA 303
[1] [3]



Bologna LA 301B
[1] [3]



4x 40 mm breite
geprägte Linien

Optional mit folgenden
Funktionen erhältlich:

[1] Schallschutz



[2] Einbruchhemmung



[3] Klimabeständigkeit



[4] Feuer-/Rauchschutz





Designtüren Bologna



Bologna LA 301S
[1] [3]

Bologna LA 301M
[1] [3]

Bologna LA 302
[1] [3]

Leichtigkeit
trifft Eleganz -
eine Optik mit
Mehrwert.

Innentüren mit ausdrucksstarken
40 mm breiten Querprägungen
beleben die Atmosphäre der
Räume.



Beschreibung der Details:



Türblattprofil
Glattkante



30 mm breite
Rahmen



ähnl.
RAL 9010

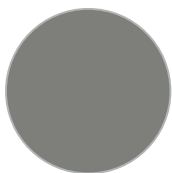

auch in
RAL 7037
erhältlich (Kleine
Rundkante)



Ancona
[1] [2] [3] [4]



Ancona LA

Optional mit folgenden
Funktionen erhältlich:

[1] Schallschutz



[2] Einbruchhemmung



[3] Klimabeständigkeit



[4] Feuer-/Rauchschutz





Stiltüren Ancona



Ancona 3
[1] [2] [3] [4]

Ancona 3 LA

Tradition
trifft Moderne -
elegante
Aufwertung für
Ihre Räume.

Klassische Innentüren im
zeitgemäßen, reduzierten Look für
höchste Ansprüche.



Beschreibung der Details:



Türblattprofil
Kleine Rundkante



30 mm breite
Rahmen



ähnl.
RAL 9003

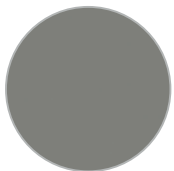

auch in
RAL 7037
erhältlich (Kleine
Rundkante)

Optional mit folgenden
Funktionen erhältlich:

[1] Schallschutz



[2] Einbruchhemmung



[3] Klimabeständigkeit



[4] Feuer-/Rauchschutz



Ancona
[4]



Ancona LA



Stiltüren

Ancona 9003



Ancona 3
[4]

Ancona 3 LA

Das weißere
Weiß -
perfektes
optisches
Zusammenspiel
mit Weißlack-
möbeln

Die Innentüren in extraweiß sind
passend auf die Wandfarben
bekannter Hersteller abgestimmt.
Sie passen wunderbar zum
aktuellen Mobiliar und bilden so
im Gesamtbild eine Einheit.



Beschreibung der Details:



Türblattprofil
Rundkante

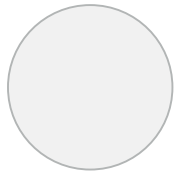

ähnl.
RAL 9010

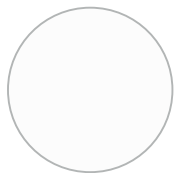

auch in
RAL 9003
erhältlich

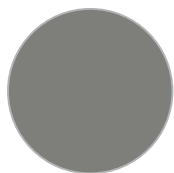

auch in RAL 7037
erhältlich (Aus-
nahme Elba 2B)
Kleine Rundkante

Optional mit folgenden
Funktionen erhältlich:

[1] Schallschutz



[2] Einbruchhemmung



[3] Klimabeständigkeit



[4] Feuer-/Rauchschutz



Elba 2
[1] [2] [3]



Elba 2 LA



Elba 2 LA SR6



Elba 2 LA SR9

Stiltüren

Elba



Elba 2 B
[1] [2] [3]



Elba 2B LA

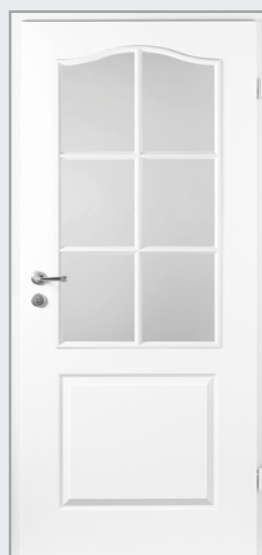

Elba 2B LA SR6



Elba 3 *
[1] [2] [3]



Elba 3 LA *



Elba 3 LA SR6

Klassisches Design trifft auf zeitlose Eleganz

Innentüren mit formgepressten Kassetten in verschiedenen Ausführungen gilt als klassische Stiltür und garantiert ein entspanntes Wohngefühl.



Profilierung



*sichtbare Friesfuge



Beschreibung der Details:



Türblattprofil
Rundkante



ähnl.
RAL 9010

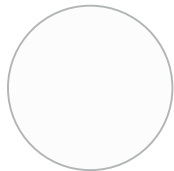

auch in
RAL 9003
erhältlich

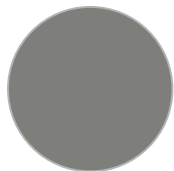

auch in
RAL 7037
erhältlich (Kleine
Rundkante)

Optional mit folgenden
Funktionen erhältlich:

[1] Schallschutz



[2] Einbruchhemmung



[3] Klimabeständigkeit



[4] Feuer-/Rauchschutz



Elba 4
[1] [2] [3]



Elba 4 LA



Elba 4 2LA

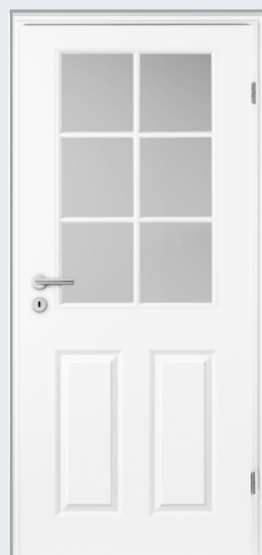

Elba 4 LA SR6

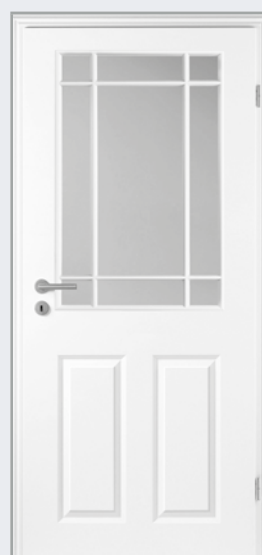

Elba 4 LA SR9



Profilierung



*sichtbare
Friesfuge

Stiltüren

Elba



Elba 4Q *
[1] [2] [3]



Elba 4Q LA *



Elba 4Q 1LA *



Elba 4Q 3LA *



Elba 4Q LA SR8 *

Klassisches
Design trifft
auf zeitlose
Eleganz



Beschreibung der Details:



Türblattprofil
Rundkante



Türblattprofil
Kleine Rundkante
nur CPL weiß
ähnl. 9003



CPL weiß ähnl. RAL 9010
Rundkante
[1] [2] [3] [4]



CPL weiß ähnl. RAL 9003
Kleine Rundkante
[1] [2] [3] [4]



LA 300
[1] [3]



LA 302
[1] [3]

Optional mit folgenden
Funktionen erhältlich:

[1] Schallschutz



[2] Einbruchhemmung



[3] Klimabeständigkeit



[4] Feuer-/Rauchschutz



CPL-Türen Standard-Dekore



CPL Ahorn
Rundkante
[1] [2] [3] [4]



CPL Buche
Rundkante
[1] [2] [3] [4]



CPL Kalkeiche
Rundkante
[1] [2] [3] [4]

CPL-
Oberflächen
- robust und
pflegeleicht

CPL-Innentüren sind eine echte
Alternative. Sie sind besonders
robust, widerstandsfähig,
pflegeleicht und lichtecht.



LA 301S
[1] [3]



LA 301M
[1] [3]



LA 301B
[1] [3]



Beschreibung der Details:



Fühlbare
Struktur



Türblattprofil
Rundkante



Eiche natur A
[1] [2] [3] [4]



Nordlandlärche A
[1] [2] [3] [4]



LA 300
[1] [3]



LA 302
[1] [3]

Optional mit folgenden
Funktionen erhältlich:

[1] Schallschutz



[2] Einbruchhemmung



[3] Klimabeständigkeit



[4] Feuer-/Rauchschutz



CPL-Türen Trend-Dekore



Rauchlärche A
[1] [2] [3] [4]



Pinie Magno A
[1] [2] [3] [4]

CPL-
Oberflächen -
fühlbar
authentisch und
Akzente setzend

CPL-Innentüren mit einer
fühlbaren strukturierten
Oberfläche sind zeitlos und doch
modern.



LA 301S
[1] [3]



LA 301M
[1] [3]



LA 301B
[1] [3]



Beschreibung der Details:



Fühlbare
Struktur



Türblattprofil
Rundkante



Eiche natur Q
[1] [2] [3] [4]



Nordlandlärche Q
[1] [2] [3] [4]



LA 300
[1] [3]



LA 302
[1] [3]

Optional mit folgenden
Funktionen erhältlich:

[1] Schallschutz



[2] Einbruchhemmung



[3] Klimabeständigkeit



[4] Feuer-/Rauchschutz



CPL-Türen Trend-Dekore



Rauchlärche Q
[1] [2] [3] [4]



Pinie Magno Q
[1] [2] [3] [4]

Wirkungsvolle
Optik - einfach
spürbar schön

Innentüren mit einer fühlbaren
querlaufenden Oberflächen-
Struktur in trendigen Farbtönen
werten Ihr Raum-Design auf.



LA 301S
[1] [3]



LA 301M
[1] [3]



LA 301B
[1] [3]



Edelstahl Klasse 2
Klipptechnik



Bergamo



Como



Garda



Mailand



Palermo



Roma



WC-Ausführung



PZ-Ausführung



Knauf

Bicolor Klasse 2
Klipptechnik



Catania



Genua



WC-Ausführung



PZ-Ausführung



Knauf

Beschläge Übersicht



Monza



Parma



WC-Ausführung



PZ-Ausführung



Knauf

Edelstahl Klasse 3
Klipptechnik



Bergamo

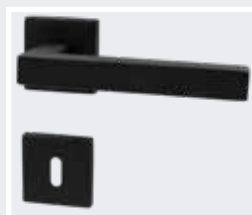

Monza



WC-Ausführung

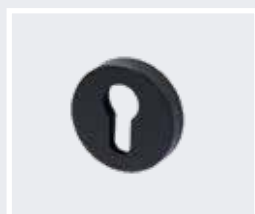

PZ-Ausführung



Knauf

Edelstahl schwarz
Klipptechnik

Schutzbeschläge



Schutzbeschlag
Edelstahl black

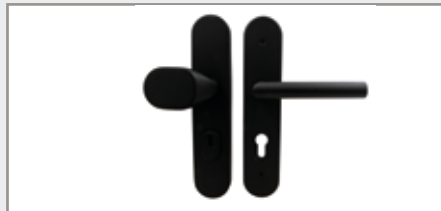

ES1-L-ZA L-Form-Drücker

Kombischutzbeschlag
Edelstahl black



ES1-L-ZA L-Form-Drücker

Schutzbeschlag
Edelstahl matt



ES1-L-ZA L-Form-Drückergarnitur



ES1-L-ZA U-Form-Drückergarnitur

Kombischutzbeschlag
Edelstahl matt



ES1-L-ZA L-Form-Drückergarnitur



ES1-L-ZA U-Form-Drückergarnitur

Zargen und Zubehör

Zierbekleidung Rundkante – Standard

Bestellmaß	80	100	120	140	160	180	200	240	265	280	300	330
Verstell- von	80	100	120	140	160	180	200	240	265	280	300	330
bereich bis	97	117	137	157	177	197	217	257	282	297	317	347

Zierbekleidung Rundkante – Verlängerte Feder (Zubehör zum Austausch)

Bestellmaß	80	100	120	140	160	180	200	240	265	280	300	330
Verstell- von	80	100	120	140	160	180	200	240	265	280	300	330
bereich bis	117	137	157	177	197	217	237	277	302	317	337	367

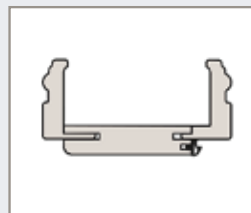
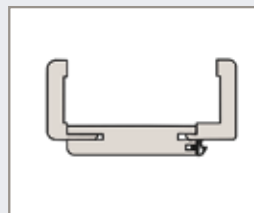
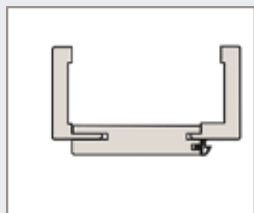
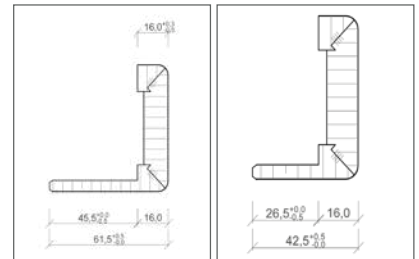

kleine Rundung ca. 2 mm Radius

Rundkante ca. 5 mm Radius

Profiliert

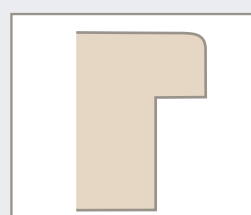
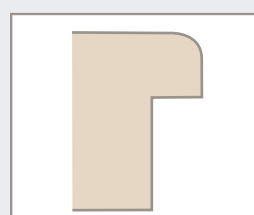
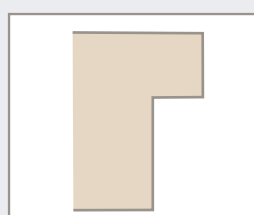
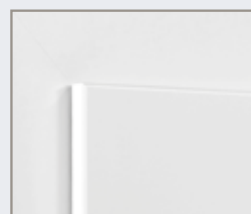
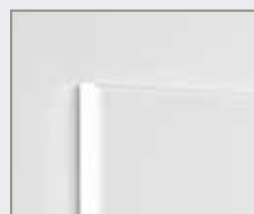

Glattkante

Rundkante

Kleine Rundkante

Zargenprofile

Türblattprofile

Türentechnik

DIN 4109

Da die DIN 4109 in allen Bundesländern als technische Baubestimmung eingeführt ist, sind die Mindestbestimmungen bezüglich der Schalldämmung von Türen zwischen bestimmten Bereichen und Räumen verbindlich.

Baustelle	Anforderungen R _w * in (dB)	Vorhaltemaß in (dB)	um das Vorhaltemaß erhöhte Anforderung R _w * in (dB)	Schallschutz- klassen (SK)
Geschosshäuser mit Wohnungen und Arbeitsräumen Türen, die von Haustüren oder Treppenträumen in Flure und Dielen von Wohnungen und Wohnheimen oder Arbeitsräumen führen.	27	5	32	SK 1
Beherbergungsstätten Türen zwischen Fluren und Übernachtungsräumen	32	5	37	SK 2
Krankenanstalten, Sanatorien Türen zwischen Fluren und Krankenräumen, Operations- oder Behandlungsräumen, Fluren und Operations- oder Behandlungsräumen	32	5	37	SK 2
Schulen und vergleichbare Unterrichtsräume Türen zwischen Unterrichtsräumen oder ähnlichen Räumen und Fluren	32	5	37	SK 2
Geschosshäuser mit Wohnungen und Arbeitsräumen Türen, die von Haustüren oder Treppenträumen unmittelbar in Aufenthaltsräume (außer Flure und Dielen) von Wohnungen führen.	37	5	42	SK 3
Krankenanstalten, Sanatorien Türen zwischen Untersuchungs- oder Sprechzimmern, Fluren und Untersuchungs- oder Sprechzimmern	37	5	42	SK 3

Die in der Tabelle angegebenen Werte sind Mindestanforderungen nach DIN 4109

* R_w - Bewertetes Schalldämm-Maß in dB mit Schallübertragung über flankierende Bauteile

R_w - Bewertetes Schalldämm-Maß (im Prüfraum) in dB ohne Schallübertragung über flankierende Bauteile

Schallschutz

Klimaklassen Hygrothermische Prüfungen

Klimakategorie (vereinfachte Tabellendarstellung aus RAL-GZ 426)	Fläche 1 (Öffnungsfläche)	Fläche 2 (Schließfläche)
I	23°C, 30% RLF	18°C, 50% RLF
II	23°C, 30% RLF	13°C, 65% RLF
III	23°C, 30% RLF	3°C, 85% RLF

Eine hygrothermische Beanspruchung der Türen liegt dann vor, wenn ein Türblatt auf beiden Seiten unterschiedlichen Klimaten oder beidseits gleichen Klimaten, aber sehr trockenem oder feuchtem Klima ausgesetzt ist. Dies ist beispielsweise bei Wohnungsabschlusstüren der Fall.

Bei der Prüfung der Türblätter werden diese für einen festgesetzten Zeitraum in einer Prüfkammer unterschiedlichen Klimaten ausgesetzt.

Geprüfte und zertifizierte einbruchhemmende Türen nach DIN EN 1627 bzw. DIN V ENV 1627

(vereinfachte Tabellendarstellung aus RAL-GZ 426)	„neue“ DIN EN 1627	„alte“ DIN V ENV 1627
↓	RC 2	WK 2
Einbruch-	RC 3	WK 3
kemmung	RC 4	WK 4
steigend	RC 5	WK 5
↓	RC 6	WK 6

- RC2/RC3 = im privaten Bereich üblicherweise ausreichend
- RC 2 = normale Einbruchshemmung
- RC 3 = erhöhte Einbruchshemmung
- RC 4 = hohe Einbruchshemmung (findet überwiegend im gewerblichen Bereich Verwendung)

Einbruchhemmende Türen werden in sechs Widerstandsklassen (RC 1 bis RC 6) eingeteilt, wobei RC 6 für die höchste Widerstandsklasse steht (RC = resistance class). Empfehlenswert sind Türen ab der Widerstandsklasse RC 2.

Gleichwertig sind Türen, die nach der bisherigen, bis September 2011 gültigen Vornorm, der DIN V ENV 1627 geprüft wurden. Die Zuordnung der einzelnen Widerstandsklassen ist mit oben stehender Tabelle annähernd möglich.

Widerstandsklassen

1-flügelige Türen

Aufgrund der heute üblichen Beschlagtechnik bei Holzzargen hat es sich bewährt, die tatsächliche Maueröffnung etwa 10 bis 15 mm breiter zu erstellen als sich nach DIN 18100 ergäbe.

Man vermeidet so in aller Regel notwendige Nachstemarbeiten am Mauerwerk im Bereich der Zargenbeschläge. So sollte z.B. für eine Baurichtmaßbreite von 875 mm das tatsächliche Mauerloch für eine Holzumfassungszarge etwa 895 mm bis 900 mm breit sein!

	Türblattaußenmaße (=Zargenbestellmaße)				Zargenmaße								
	Baurichtmaß nach DIN 18100	Maueröffnungsmaß 1)	Türblatt gefälzt	Türblatt stumpf einschlagend	Falzmaß	lichtes Zargendurchgangsmaß	Zargenaußenmaße		Bekleidungsaußenmaß (ohne Falzzierleisten)				
							Futterbrettaußenmaß	inkl. rücks. Beschlagteile	Bekleidungsbreite				
									50 mm	60 mm	70 mm	80 mm	88 mm
1	2	3	4	5	6	7	7a	8	8	8	8	8	
...	1	2	3	4	5	6	7	7a	8	8	8	8	8
BREITE	625	635	610	584	591	567	612	625	691	711	731	751	767
	750	760	735	709	716	692	737	750	816	836	856	876	892
	875	885	860	834	841	817	862	875	941	961	981	1001	1017
	1000	1010	985	959	966	942	987	1000	1066	1086	1106	1126	1142
HÖHE	1125	1135	1110	1084	1091	1067	1112	1125	1191	1211	1231	1251	1267
	1250	1260	1235	1209	1216	1192	1237	1250	1316	1336	1356	1376	1392
	1875	1885	1860	1847	1854	1842	1864	1868	1904	1914	1924	1934	1942
	2000	2010	1985	1972	1979	1967	1989	1993	2029	2039	2049	2059	2067
...	2125	2135	2110	2097	2104	2092	2114	2118	2154	2164	2174	2184	2192
	2250	2260	2235	2222	2229	2217	2239	2243	2279	2289	2299	2309	2317
	2375	2385	2360	2347	2354	2342	2364	2368	2404	2414	2424	2434	2442
	2500	2510	2485	2472	2479	2467	2489	2493	2529	2539	2549	2559	2567

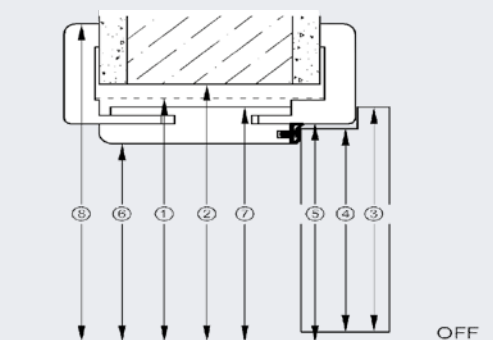
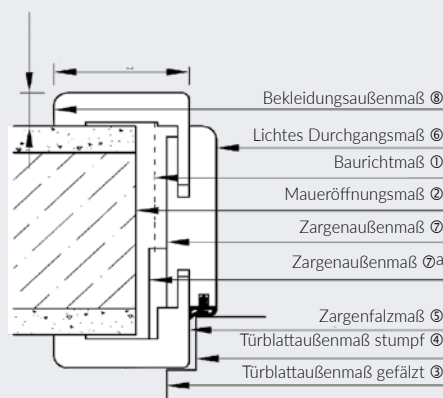

Türentechnik

Zargenmaße

2-flügelige Türen

Bau- richtmaß nach DIN 18100	Mauer- öffnungs- maß 1)	Türblattaußenmaße (=Zargenbestell- maße)		Zargenmaße								
		Türblatt gefälzt	Türblatt stumpf einschla- gend	Falzmaß	lichtes Zargen- durch- gangs- maß	Zargenaußenmaße		Bekleidungsaußenmaß (ohne Falzrierleisten)				
						Futter- brettau- ßenmaß	inkl. rücks. Beschlag- teile	Bekleidungsbreite				
								50 mm	60 mm	70 mm	80 mm	88 mm
1	2	3	4	5	6	7	7a	8	8	8	8	8
1250	1260	1210	1184	1191	1167	612	1238	1291	1311	1331	1351	1367
1500	1510	1460	1434	1441	1417	737	1488	1541	1561	1581	1601	1617
1750	1760	1710	1684	1691	1667	862	1738	1791	1811	1831	1851	1867
2000	2010	1960	1934	1941	1917	987	1988	2041	2061	2061	2101	2117
2250	2260	2210	2184	2191	2167	1112	2238	2291	2311	2331	2351	2367
2500	2510	2460	2434	2441	2417	1237	2488	2541	2561	2581	2601	2617
1875	1885	1860	1847	1854	1842	1864	1868	1904	1914	1924	1934	1942
2000	2010	1985	1972	1979	1967	1989	1993	2029	2039	2049	2069	2067
2125	2135	2110	2097	2104	2092	2114	2118	2154	2164	2174	2184	2192
2250	2260	2235	2222	2229	2217	2239	2243	2279	2289	2299	2309	2317
2375	2385	2360	2347	2354	2342	2364	2368	2404	2414	2424	2434	2442
2500	2510	2485	2472	2479	2467	2489	2493	2529	2539	2549	2559	2567

BREITE

HÖHE

HÖHE

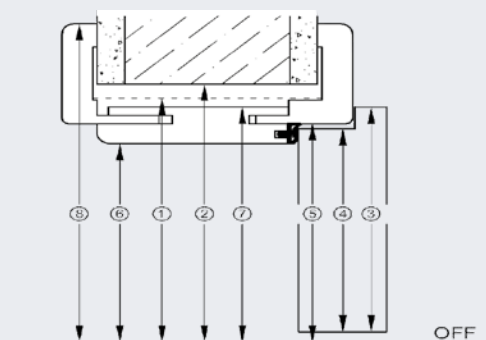
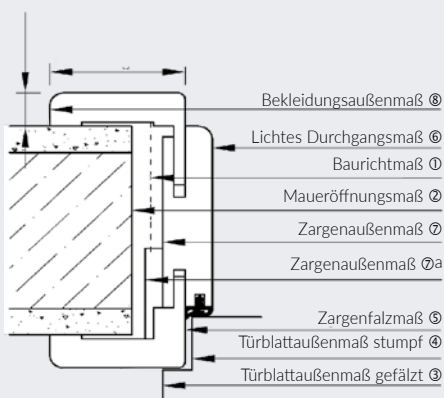

Glatte Türen

Weißlack



CPL Türen

Standard glatt
Struktur quer
Struktur aufrecht



Designtüren / geprägt

Varese



Venedig



Bologna



Stiltüren

Ancona



Stiltüren / geprägt

Elba



Glatte Türen
Weißlack



CPL Türen
Standard glatt
Struktur quer
Struktur aufrecht



Designtüren / geprägt
Varese

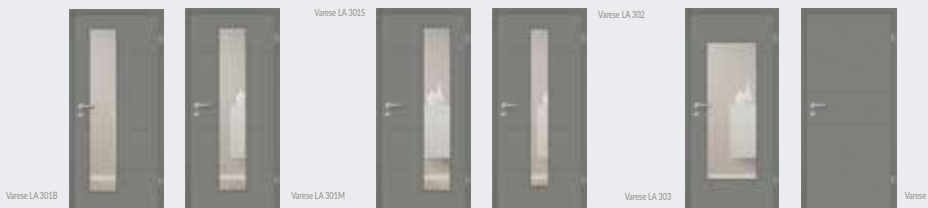

Venedig

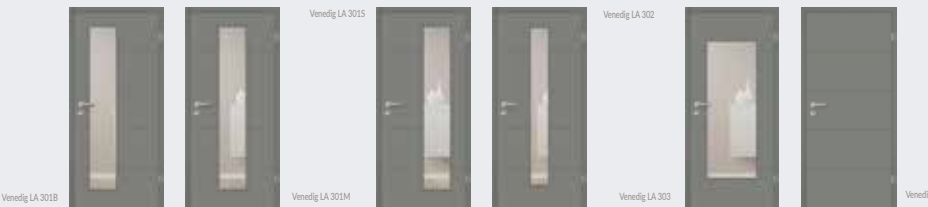

Bologna

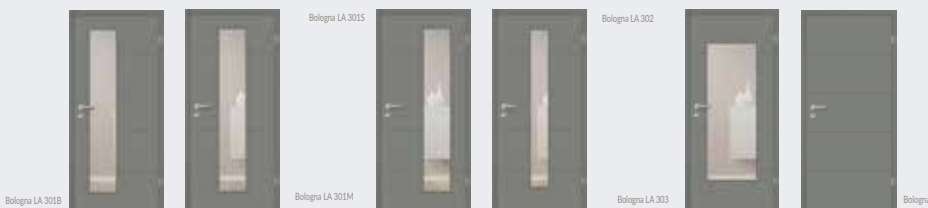

Stiltüren
Ancona



Stiltüren / geprägt
Elba

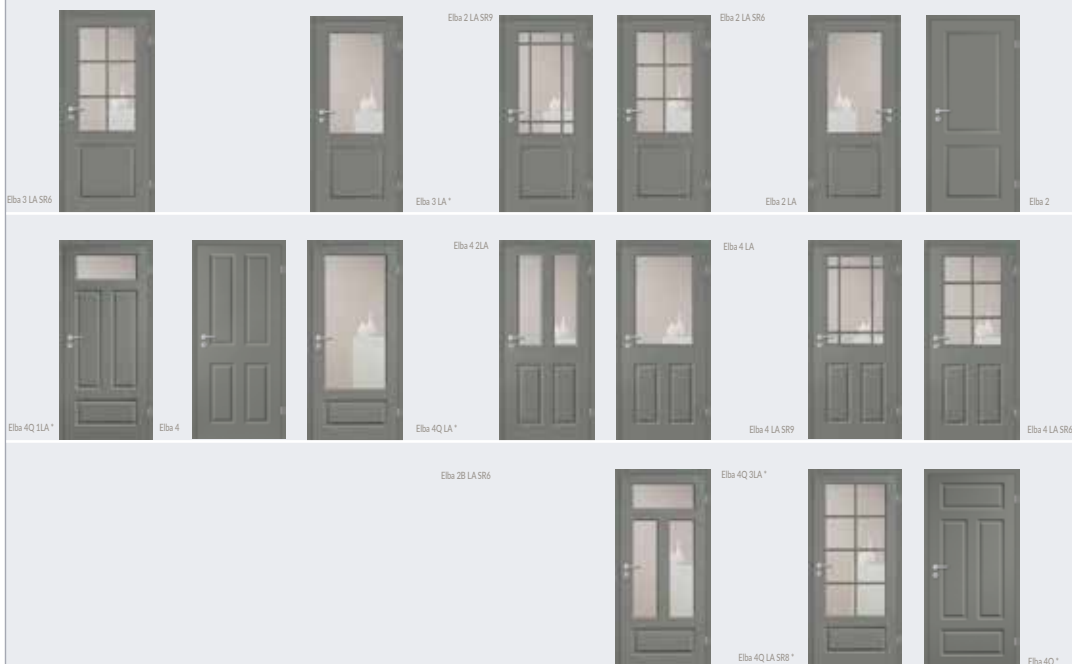



Irrtümer und techn. Änderungen vorbehalten - Stand Juli 2023

Weißlacktüren
CPL Türen
Beschläge
Zubehör



Ihr Fachhändler: